

INTEX® OWNER'S MANUAL

English

17
10

Quickfill® Plus Internal Pump

Model AP620D 220V – 240V~ 50Hz 80W

Model AP620DP 220V – 240V~ 50Hz 90W

IMPORTANT SAFETY INSTRUCTIONS

READ AND FOLLOW ALL INSTRUCTIONS BEFORE USING THIS PRODUCT

WARNING

- **NEVER PLACE AN INFANT TO SLEEP ON AIR MATTRESSES.**
- Never introduce any flammable substance into the inflatable air bed, SUCH AS AEROSOL TIRE REPAIR PRODUCTS, as it may ignite or explode.
- This is not a toy. Children must not be left unattended when using the air bed.
- Keep the storage bag (if included) away from babies and children. The storage bag is not a toy. When not in use, fold the bag and put it away out of the reach of children.
- Do not walk, stand on or jump on or use the air bed as a trampoline.
- Only for domestic use. Only for indoor use. Do not use on or near water. This is not a raft.
- Do not set up bed near stairs, doors, sharp edges or breakable objects. Provide adequate space between bed and objects to avoid entrapment.
- Make sure the area is flat, smooth, even and free of sharp objects that could puncture the bed.
- Keep pets away from the air bed. Pets may puncture the surface of the bed.
- Avoid sleeping on the edge of the air bed. Edges produce less support than the middle of the bed.
- Do not operate air pump for more than 5 minutes at a time. Let pump cool at least 15 minutes between use.
- Unplug electrical power cord when not in use.
- Do not obstruct the air passage opening or insert any objects into the air passage opening.
- If the AC supply cord is damaged, it must be replaced by the manufacturer or its service agent or similarly qualified persons in order to avoid a hazard.
- To reduce the risk of electric shock, do not expose to rain. Store indoors.
- This appliance can be used by children aged from 8 years and above and persons with reduced physical, sensory or mental capabilities or lack of experience and knowledge if they have been given supervision or instruction concerning use of the appliance in a safe way and understand the hazards involved.
- Children shall not play with the appliance. Cleaning and user maintenance shall not be made by children without supervision.

FOLLOW THESE RULES AND ALL INSTRUCTIONS TO AVOID SUFFOCATION, PROPERTY DAMAGE, ELECTRIC SHOCK, BURNS OR OTHER INJURY.

SAVE THESE INSTRUCTIONS

OPERATING INSTRUCTIONS

General

- Air beds are designed for temporary use and are NOT designed to be a replacement for a traditional mattress.
- Make sure the area is flat, level, clean and free from sharp objects, and within reach of an electrical outlet.
- To prevent puncture or damage to the air bed, never drag the air bed across the floor. Lift the inflated air bed when moving or changing location.
- No air pump maintenance is required. Pump is removable.
- For cleaning use only clean cloth with mild soapy solution. Do not use any chemicals.
- In case of repairs, use only common PVC repair glue and patches. For flocked surfaces: rub away the flocking material with an eraser first before applying the glue and/or patch.

PARTS REFERENCE

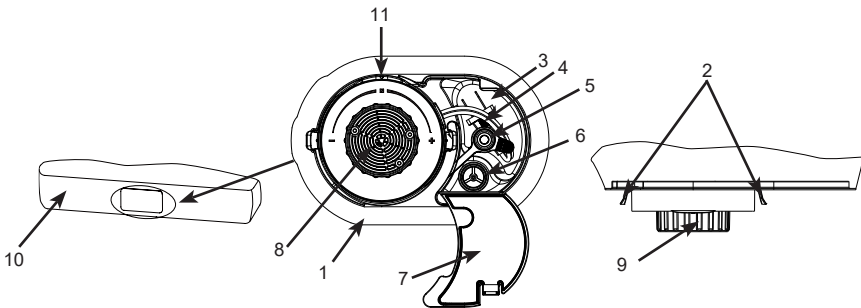

Part Descriptions:

- | | | |
|----------------------|------------------------------|--------------------------------|
| 1. Pump holder frame | 4. AC power cord | 8. Air passage |
| 2. Pump removal tab | 5. Manual inflation port cap | 9. Control dial |
| 3. Cord compartment | 6. Manual inflation port | 10. Air bed front |
| | 7. Cord compartment cover | 11. Closed / Pump Off Position |

NOTE: Drawings for illustration purpose only. May not reflect actual product. Not to scale. Due to a policy of continuous product improvement, Intex reserves the right to change specifications and appearance, which may result in updates to the instruction manual, without notice.

SAVE THESE INSTRUCTIONS

INFLATION

1. Open cord compartment cover and remove power cord. Do not yank on the cord. See Fig (1).
2. Plug in the AC power cord into an AC electrical outlet. See Fig (2).

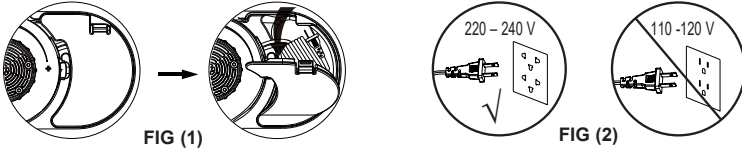

3. Turn the control dial fully clockwise until it stops. The pump turns on automatically to inflate the air bed. See Fig (3).

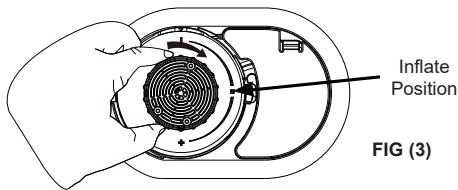

4. When the air bed is fully inflated, turn the control dial back (counterclockwise) to the center position which closes the valve and turns the pump off. See Fig (4).

NOTE: Turning the control dial either direction while the pump is unplugged will let air escape from the air bed. See step #5 for firmness adjustment instructions.

Never disconnect the power cord from the electrical outlet while the pump is running. Rotate control dial to the closed / pump off position before disconnecting the power cord.

Rotate to Closed / Pump Off Position

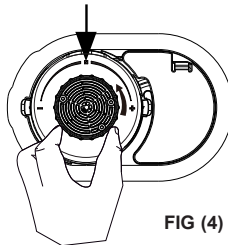

5. If the air bed feels too firm, release some air by simply turning the control dial gradually counterclockwise until air begins to escape from the air passage. When the desired firmness is achieved, turn the control dial back to the center closed / pump off position. If the air bed feels too soft, repeat steps #3 to #5 as necessary.

SAVE THESE INSTRUCTIONS

IMPORTANT NOTE

Proper inflation of the air bed.

The ambient temperatures of air have an effect on the air bed internal pressure. At low ambient temperature the air will contract within the air bed and the air bed will feel softer: add air as necessary. At high ambient temperature the air within the air bed will expand significantly and the air bed will become hard and may burst: release air to avoid damage to the air bed or to soften the feel. **Do not** expose the air bed to extreme temperatures (hot or cold).

Stretching is a natural characteristic of new vinyl. During initial use, the air bed may become soft and require additional inflation to maintain desired firmness. This is normal for the first few days of use.

Dimensions shown are approximate and will vary due to the vinyl temperature and the air temperature.

In no event shall Intex, their authorized agents or employees be liable for damages (such as pin holes) to the air bed caused by negligence, ordinary wear and tear, abuse and carelessness, or external forces.

DEFLATION

1. Plug in the AC power cord into an AC electrical outlet. See Fig (2).
2. Turn the control dial fully counterclockwise until it stops. The pump is now deflating the air bed. See Fig (5).

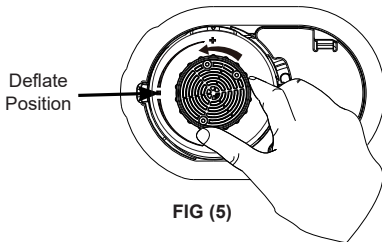

FIG (5)



FIG (6)

3. When all the air is removed from the air bed, turn the control dial back (clockwise) to the center position which closes the valve and turns the pump off.
4. Disconnect the AC power cord from the electrical outlet, coil the power cord and place it inside the cord compartment, then close the cover. Make sure the power cord is free of twists, kinks or knots.
5. With the air bed fully deflated begin rolling the air bed from the end opposite of the pump towards the end where the pump is located. See Fig (6).

MANUAL INFLATION OPTION

If electrical power is not available, a conventional foot, manual, or battery-operated air pump can be used by connecting it to the manual inflation port located inside the power cord compartment. See Fig (7). Follow these steps:

SAVE THESE INSTRUCTIONS

1. Open cord compartment cover and locate the manual inflation port.
2. Make sure the control dial of the internal electric pump is still in the closed / pump off position.
3. Remove the cap from the manual inflation port and insert the nozzle of the pump into the port. Inflate the air bed to desired firmness.

NOTE: Do not overinflate. The firmness should be approximately the same as the level achieved with the internal electric pump.

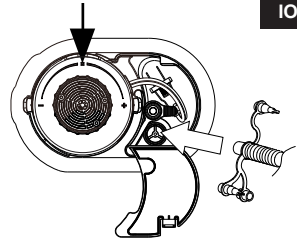

FIG (7)

4. Remove nozzle from manual inflation port and close the cap and the cord compartment cover.

STORAGE INSTRUCTIONS

1. Deflate the air bed following the "DEFLATION" instructions.
2. Make sure the air bed is clean and dry.
3. Lay the air bed flat with the sleeping surface facing upwards and follow the folding steps on Figs (8 - 12). Fold the air bed loosely and avoid sharp bends, corners and creases which can damage the air bed.



FIG (8)



FIG (9)



FIG (10)

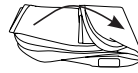

FIG (11)



FIG (12)

REPLACING INTERNAL AIR PUMP OR THE AIR BED COMPONENT

If there is a need to replace either the internal air pump or the air bed portion, detach the internal pump from the air bed as follows:

1. While holding both lock tabs pressed inward (see Figure 13), turn the round body of the pump (the large outer rim, not the control dial) counterclockwise and pull the air pump body out of the holder frame.

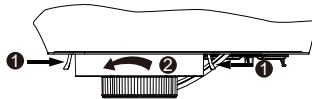

FIG (13)

2. Depending on which part is being replaced, keep the remaining component (either the air bed portion or the removed pump) in a safe place until the replacement part is received. Reattach the components when the new part is received: simply place the pump into the holder frame and turn clockwise until the lock tabs click into place.

NOTE: Make sure the rubber seal on the pump housing as well as the inside wall of the holder frame are clean and free from any lint, hair or dirt, to ensure a proper seal and avoid air leaks.

NOTE: Do not remove internal air pump from the holder frame other than for servicing, as this may introduce lint, hair or dirt into the seal area and cause air leaks. If air leak is experienced, check that the seal is clean before replacing the pump or the air bed.

SAVE THESE INSTRUCTIONS

TROUBLESHOOTING GUIDE

PROBLEM	CAUSE	SOLUTION
Air leakage between internal air pump and the pump holder frame	<ul style="list-style-type: none"> • Pump not securely attached. • Pump O-ring is dirty. • Internal air bed beam threads are caught between the internal air pump and the pump holder frame. • Pump O-ring is twisted and/or damaged. 	<ul style="list-style-type: none"> • While holding the pump outer rim, push in and turn the pump fully clockwise until the two side tabs lock into place. • Remove the pump from the air bed, remove the O-ring from the pump and clean it with water. Carefully replace the O-ring back to the pump as to prevent dust, lint from sticking onto the O-ring again. Also make sure the pump holder frame inner wall is free from dust, hair or lint. • Remove the internal air pump and carefully replace the pump back making sure the internal air bed beam threads are away from the pump holder frame. • Remove the pump from the air bed, make sure the O-ring is not damaged and/or twisted. Realign the O-ring or replace a new O-ring. Contact Intex service center for replacement.
Air pump does not work	<ul style="list-style-type: none"> • Not connected to an electrical outlet socket. • Pump motor thermo-protector activated. • Internal air pump defective. 	<ul style="list-style-type: none"> • Make sure the pump is plugged into the correct power outlet, then turn the control dial fully clockwise to the inflation position. • Turn off and disconnect the power cord from the power outlet, let the pump rest for more than 30 minutes before resume the use of the pump. • Remove the internal air pump from the air bed and keep the air bed in a safe place. Contact Intex service center for an internal air pump replacement.
Pump motor is running but air bed is not inflating or deflating	<ul style="list-style-type: none"> • The inflation or deflation mode is not set yet. 	<ul style="list-style-type: none"> • Turn the control dial fully clockwise until it stops to inflate the air bed. Or turn the control dial fully counterclockwise until it stops to deflate the air bed.
After inflation air is escaping through the pump air passage or through the manual inflation port	<ul style="list-style-type: none"> • The pump air passage is not completely closed. • The manual inflation port cap is not securely closed. 	<ul style="list-style-type: none"> • Make sure the air passage is closed by turning the control dial to the center closed / pump off position. • Push the cap firmly into the manual inflation port.

©2023 Intex Marketing Ltd. - Intex Development Co. Ltd. - Intex Recreation Corp. All rights reserved/Tous droits réservés/Todos los derechos reservados/Alle Rechte vorbehalten. Printed in China/Imprimé en Chine/Impreso en China/Gedruckt in China.

®™ Trademarks used in some countries of the world under license from®™ Marques utilisées dans certains pays sous licence de/Marcas registradas utilizadas en algunos países del mundo bajo licencia de/Warenzeichen verwendet in einigen Ländern der Welt in Lizenz von/Intex Marketing Ltd. to/a/a/an Intex Development Co. Ltd., Hong Kong & Intex Recreation Corp., P.O. Box 1440, Long Beach, CA 90801 • Distributed in the European Union by/Distribué dans l'Union Européenne par/Distribuido en la unión Europea por/Vertrieb in der Europäischen Union durch/Intex Trading B.V., Ettenseweg 46, 4706 PB Roosendaal - The Netherlands • Distributed in the UK by Unitex Service (UK) Limited, 21 Holborn Viaduct, London EC1A 2DY, UK. www.intexcorp.com

INTEX®

SAVE THESE INSTRUCTIONS